



SUNNY BOY STORAGE

Approved Batteries and Information on Battery Communication Connection

Table of Contents

1	Approved Batteries.....	3
1.1	SBS2.5-1VL-10 / SBS3.7-10 / SBS5.0-10 / SBS6.0-10.....	3
1.2	SBS3.8-US-10 / SBS5.0-US-10 / SBS6.0-US-10.....	10
2	Battery Communication Connection.....	12
2.1	Cable Requirements.....	12
2.1.1	SBS2.5-1VL-10.....	12
2.1.2	SBS3.7-10 / SBS5.0-10 / SBS6.0-10.....	12
2.1.3	SBS3.8-US-10 / SBS5.0-US-10 / SBS6.0-US-10.....	12
2.2	Cabling Plan.....	13
2.2.1	SBS2.5-1VL-10.....	13
2.2.2	SBS3.7-10 / SBS5.0-10 / SBS6.0-10.....	15
2.2.3	SBS3.8-US-10 / SBS5.0-US-10 / SBS6.0-US-10.....	22
3	Information about the electrical connection.....	26

1 Approved Batteries

1.1 SBS2.5-1VL-10 / SBS3.7-10 / SBS5.0-10 / SBS6.0-10

In the tables you will find the batteries which are approved for operation with the following battery inverters of SMA Solar Technology AG (status: 2023/03):

- SBS2.5-1VL-10 (Sunny Boy Storage 2.5)
- SBS3.7-10 (Sunny Boy Storage 3.7)
- SBS5.0-10 (Sunny Boy Storage 5.0)
- SBS6.0-10 (Sunny Boy Storage 6.0)

i Firmware version of the battery

The firmware version of the battery can be accessed via the user interface of the inverter. The firmware version of the BYD batteries can also be accessed via the user interface of the battery (see manufacturer's manual). With the exception of the BYD Battery-Box (H, Premium HVS and HVM), LG RESU (10H Prime, 16H Prime and Flex) and Pylontech (Force-H1-V2 and Force-H2-V2), the battery firmware is automatically updated via the inverter.

i Inverter firmware version

The firmware version of the inverter can be accessed via the user interface of the inverter.

Battery type (Manufacturer)	Modules	Firmware version of battery:		Firmware version of inverter:	
		SBS2.5-1VL-10	SBS3.7-10, SBS5.0-10, SBS6.0-10	SBS2.5-1VL-10	SBS3.7-10, SBS5.0-10, SBS6.0-10
AXIstorage Li SH 7.5-15 ¹⁾ Item no.: 42257 and 611274, both with Helios 1.5 module (item no.: 37832-02) (AXITEC)	3-6	Not released	≥ 0.03.07.R	Not released	≥ 3.11.10.R
AXIstorage Li SH 7.5-15 ¹⁾ Item no.: 616344 and 616039, both with Helios VE module (Item no.: 612033) (AXITEC)	3-6	Not released	≥ 0.03.15.R	Not released	≥ 3.12.61.R
Hyperion 7.5-15 ¹⁾ Item no.: 41871 with Helios 1.5 module (item no. 37832-02) (BMZ GmbH)	3-6	Not released	≥ 0.03.07.R	Not released	≥ 3.11.10.R

¹⁾ The battery type is only compatible with the mentioned item number (item no.).

Battery type (Manufacturer)	Modules	Firmware version of battery:		Firmware version of inverter:	
		SBS2.5-1VL-10	SBS3.7-10, SBS5.0-10, SBS6.0-10	SBS2.5-1VL-10	SBS3.7-10, SBS5.0-10, SBS6.0-10
Hyperion 7.5-15 ¹⁾ Item no.: 615424 and 616038, both with Helios VE module (Item no.: 612033) (BMZ GmbH)	3-6	Not released	≥ 0.03.15.R	Not released	≥ 3.12.61.R
era:powerbase 7.5-15 ¹⁾ Item no.: 42256 and 611273, both with Helios 1.5 module (item no.: 37832-02) (IBC SOLAR AG)	3-6	Not released	≥ 0.03.07.R	Not released	≥ 3.11.10.R
era:powerbase 7.5-15 ¹⁾ Item no.: 615423 and 609811, both with Helios VE module (Item no.: 612033) (IBC SOLAR AG)	3-6	Not released	≥ 0.03.15.R	Not released	≥ 3.12.61.R
Battery-Box H 5.1-10.2 (BYD Company Limited)	4-8	3.00.04.R to 3.00.15.R	3.00.04.R to 3.00.15.R	≥ 2.04.23.R	≥ 1.00.20.R
Battery-Box Pre- mium HVS 5.1-10.2 ²⁾ (BYD Company Limited)	2-4	BMU ≥ 3.13 BMS ≥ 3.19	BMU ≥ 3.13 BMS ≥ 3.19	≥ 3.11.06.R	≥ 3.11.10.R
Battery-Box Pre- mium HVM 8.3-22.1 (BYD Company Limited)	3-8	Not released	BMU ≥ 3.13 BMS ≥ 3.19	Not released	≥ 3.11.03.R

²⁾ When using the BYD Battery-Box Premium HVS with the Sunny Boy Storage 2.5, you must select the Sunny Boy Storage 2.5 inverter during configuration. Observe the information on the current Sunny Boy Storage 2.5 firmware package in the readme file in the download area at www.SMA-Solar.com.

Battery type (Manufacturer)	Modules	Firmware version of battery:		Firmware version of inverter:	
		SBS2.5-1VL-10	SBS3.7-10, SBS5.0-10, SBS6.0-10	SBS2.5-1VL-10	SBS3.7-10, SBS5.0-10, SBS6.0-10
RESU 7H / EH111063P3S3 Type C (LG Energy Solu- tion)	Not modular	≥ 15.02.4.R	≥ 16.02.6 R	≥ 2.04.23.R	≥ 1.00.20.R
RESU 10H / 15563P3SDLT Type C (LG Energy Solu- tion)	Not modular	≥ 13.13.0.R	≥ 16.13.6 R	≥ 2.04.14.R	≥ 1.00.20.R
RESU 10M (LG Energy Solu- tion)	Not modular	Not released	≥ 1.01.1 R (only approved for SBS3.7-10)	Not released	≥ 3.11.03.R
RESU 10H Prime (LG Energy Solu- tion)	Not modular	Not released	≥ 23.12.0 R	Not released	≥ 3.12.23.R
RESU 16H Prime (LG Energy Solu- tion)	Not modular	Not released	≥ 23.12.0 R	Not released	≥ 3.12.23.R
RESU Flex (8.6-17.2) (LG Energy Solu- tion)	2-4	Not released	≥ 1.0.0.4.R	Not released	≥ 3.14.10.R
Force-H1-V2 (10.65-24.86) (Pylon Technolo- gies Company Lim- ited)	3-7	Not released	≥ 1.2.0.R	Not released	≥ 04.04.03.R
Force-H2-V2 (7.10-14.20) (Pylon Technolo- gies Company Lim- ited)	2-4	Not released	≥ 1.2.0.R	Not released	≥ 04.04.03.R

Synchronizing the battery and battery inverter

All batteries mentioned supply a defined nominal current. Please pay attention to the battery manufacturer's recommendation regarding the suitable dimensioning of the battery in order to achieve the nominal and overload currents of the systems stated in the datasheet with a Sunny Boy Storage. Only if the dimensioning of the battery size is synchronized (battery capacity, battery currents, number of battery modules if necessary), the full functionality and power incl. overload can be guaranteed for the PV storage system with the respective battery inverter in use.

Recommendations for the use in various systems for SBS2.5-1VL-10:

Battery type (Module configuration)	Use in systems for/with		
	Increased self-consumption	Secure power supply operation	Battery-backup operation
Battery-Box H (5.1 - 10.2)	✓	✗	✗
Battery-Box Premium HVS (5.1-10.2)	✓	✗	✗
RESU 7H type C	✓	✗	✗
RESU 10H type C	✓	✗	✗

✓ = Yes, ✗ = No

Recommendations for the use in various systems for SBS3.7-10 / SBS5.0-10 / SBS6.0-10:

Battery type (Module configuration)	Increased self-consumption	Secure power supply operation	Battery-backup operation	Multi-battery operation with batteries	
				of the same type	of the different type
AXIstorage Li SH (7.5-15) ¹⁾ Item no.: 42257, 611274, 616344 and 616039	✓	✓	✓	✗ in planning	✗
era:powerbase (7.5-15) ¹⁾ Item no.: 42256, 611273, 615423 and 609811	✓	✓	✓	✗ in planning	✗
Hyperion (7.5-15) ¹⁾ Item no.: 41871, 615424 and 616038	✓	✓	✓	✗ in planning	✗

Battery type (Module configuration)	Use in systems for/with				
	Increased self-consumption	Secure power supply operation	Battery-backup operation	Multi-battery operation with batteries	
				of the same type	of the different type
Battery-Box H (5.1-10.2)	✓	✓	✓	✓	✓ RESU 7H and 10H, RESU 10M, RESU Flex, HVS, HVM
Battery-Box Premium HVS (5.1-10.2)	✓	✓	✓	✓	✓ RESU 10M, RESU Flex, HVM, Battery-Box H
Battery-Box Premium HVM (8.3-22.1)	✓	✓	✓	✓	✓ RESU 10M, RESU Flex, HVM, Battery-Box H
RESU 7H Type C	✓	✓	✗ (✓ ³⁾)	✓	✓ RESU 10H, Battery-Box H
RESU 10H Type C	✓	✓	✗ (✓ ³⁾)	✓	✓ RESU 7H, Battery-Box H
RESU 10M	✓	✓	✓	✓	✓ RESU Flex, Battery-Box H, HVS, HVM
RESU 10H Prime	✓	✓	✓	✓	✓ RESU 16H Prime, RESU Flex
RESU 16H Prime	✓	✓	✓	✓	✓ RESU 10H Prime, RESU Flex

³⁾ Depending on the state of charge in terms of battery and PV generation, it can happen that the battery-backup grid is interrupted for a few seconds in battery-backup operation mode during load changes and then restarts again. To prevent this behavior, SMA Solar Technology AG recommends to set the parameters **Output power limitation of PV inverter**, **Permanently derated** and **Upper limit for the charging state for derating of the PV inverters** to 0. If this setting is enabled, the battery can no longer be charged by the PV system during battery-backup operation.

Battery type (Module configuration)	Use in systems for/with				
	Increased self-consumption	Secure power supply operation	Battery-backup operation	Multi-battery operation with batteries	
				of the same type	of the different type
RESU Flex (8.6-17.2)	✓	✓	✓	✓	✓ RESU 10H/16H Prime, Battery-Box H, HVS, HVM
Force-H1-V2 (10.65-24.86)	✓	✓	✓	✓	✓ Force-H2-V2, Battery-Box H, HVS, HVM, RESU 10M, RESU Flex
Force-H2-V2 (7.10-14.20)	✓	✓	✓	✓	✓ Force-H1-V2, Battery-Box H, HVS, HVM, RESU 10M, RESU Flex

✓ = Yes, ✗ = No

i Battery-backup operation with RESU 10H/16H Prime

The RESU 10H/16H Prime can be used in battery-backup systems. Due to the integrated DC-to-DC controller in the battery, restrictions can occur with very large load jumps depending on the state of charge. In this case, the system restarts automatically after a short interruption of the battery-backup grid of 1 to 2 seconds.

Recommendations for use for SBS3.7-10 / SBS5.0-10 / SBS6.0-10:

Type	Module configuration		SBS3.7-10	SBS5.0-10	SBS6.0-10
	Capacity (kWh)	Modules			
Hyperion era:powerbase AXIstorage Li SH	7.5	3	✓	(✓)	(✓)
	10	4	✓	✓	✓
	12.5	5	✓	✓	✓
	15	6	✓	✓	✓
Battery-Box H	5.1	4	✓	(✓)	(✓)
	6.4	5	✓	✓	(✓)
	7.7	6	✓	✓	✓
	9.0	7	✓	✓	✓
	10.2	8	✓	✓	✓

Type	Module configuration		SBS3.7-10	SBS5.0-10	SBS6.0-10
	Capacity (kWh)	Modules			
Battery-Box Premium HVS	5.1	2	✓	(✓)	(✓)
	7.7	3	✓	✓	✓
	10.2	4	✓	✓	✓
Battery-Box Premium HVM	8.3	3	✓	(✓)	(✓)
	11.0	4	✓	✓	(✓)
	13.8	5	✓	✓	✓
	16.6	6	✓	✓	✓
	19.3	7	✓	✓	✓
	22.1	8	✓	✓	✓
RESU 7H type C	Not modular		✓	✓	✓
RESU 10H type C	Not modular		✓	✓	✓
RESU 10M	Not modular		✓	✗	✗
RESU 10H Prime	Not modular		✓	✓	✓
RESU 16H Prime	Not modular		✓	✓	✓
RESU Flex	8.6	2	✓	✓	(✓)
	12.9	3	(✓)	✓	✓
	17.2	4	(✓)	(✓)	✓
Force-H1-V2	10.65	3	✓	(✓)	(✓)
	14.2	4	(✓)	(✓)	✓
	17.76	5	(✓)	(✓)	✓
	21.31	6	(✓)	(✓)	✓
	24.86	7	(✓)	(✓)	✓
Force-H2-V2	7.10	2	✓	✗	✗
	10.65	3	✓	(✓)	(✓)
	14.20	4	(✓)	(✓)	✓

✓ = Yes, (✓) = Limited approval, ✗ = No

Background information on the limited approval of some inverter/battery combinations

Example: In the worst-case scenario, the BYD Battery-Box Premium HVM 8.3 can only provide a maximum output power of 3700 W, depending on the SOC. For this application, the SBS3.7 is completely sufficient. Operation with the SBS5.0/6.0 is technically possible, but does not make economic sense due to oversizing.

1.2 SBS3.8-US-10 / SBS5.0-US-10 / SBS6.0-US-10

In the tables you will find the batteries which are approved for operation with the following battery inverters of SMA Solar Technology AG (status: 2022/09):

- SBS3.8-US-10 (Sunny Boy Storage 3.8-US)
- SBS5.0-US-10 (Sunny Boy Storage 5.0-US)
- SBS6.0-US-10 (Sunny Boy Storage 6.0-US)

i Firmware version of the battery

The firmware version of the battery can be accessed via the user interface of the inverter. The firmware version of the BYD batteries can also be accessed via the user interface of the battery (see manufacturer's manual). With the exception of the BYD Battery-Box (H, Premium HVL) and LG RESU 16H Prime, the battery firmware is automatically updated via the inverter.

i Inverter firmware version

The firmware version of the inverter can be accessed via the user interface of the inverter.

i The batteries are UL 9540 certified.

These batteries are certified for the operation with the Sunny Boy Storage in SMA Energy Storage systems according to UL 9540. The batteries are listed in accordance with UL 9540.

Type (Manufacturer)	Firmware version of battery:	Firmware version of inverter:
Battery-Box H (5.0-10.0) (BYD Company Limited)	≥ 3.00.04R	≥ 1.00.20.R
Battery-Box Premium HVL (12.0-32.0) (BYD Company Limited)	≥ BMU 3.15.R ≥ BMS 3.22.R	≥ 3.12.23.R
RESU 10H / R15563P3SDLT (LG Energy Solution)	≥ 16.13.6 R ⁴⁾	≥ 1.00.20.R
RESU 16H Prime (LG Energy Solution)	≥ 23.12.0.R	≥ 3.12.23.R

Synchronizing the battery and battery inverter

All batteries mentioned supply a defined nominal current. Please pay attention to the battery manufacturer's recommendation regarding the suitable dimensioning of the battery in order to achieve the nominal and overload currents of the systems stated in the datasheet with a Sunny Boy Storage. Only if the dimensioning of the battery size is synchronized (battery capacity, battery currents, number of battery modules if necessary), the full functionality and power incl. overload can be guaranteed for the PV storage system with the respective battery inverter in use.

⁴⁾ The firmware version of the battery can be updated via the user interface of the inverter.

Recommendations for the use in various systems for SBS3.8-US-10 / SBS5.0-US-10 / SBS6.0-US-10:

i Battery-backup operation with RESU 16H Prime

The RESU 16H Prime can be used in battery-backup systems. Due to the integrated DC-to-DC controller in the battery, depending on the state of charge and the PV inverter used, restrictions may occur with very large load jumps (approx. 3 kW when used with the Sunny Boy-US). In this case, the system restarts automatically after a short interruption of the battery-backup grid of 1 to 2 seconds.

Type (module configuration)	Increased self-consumption	Secure power supply operation	Use in systems for/with		
			Battery-backup operation	Multi-battery operation with batteries	
				of the same type	of the different type
Battery-Box H (5.1-10.2) (BYD Company Limited)	✓	✓	✓	✓	✓ RESU 10H, HVL
Battery-Box Premium HVL (12.0-32.0) ⁵⁾ (BYD Company Limited)	✓	✓	✓	✓	✓ Battery-Box H
RESU 10H type C (LG Energy Solution)	✓	✓	✓ ⁶⁾	✓	✓ Battery-Box H
RESU 16H Prime (LG Energy Solution)	✓	✓	✓	✓	✗

✓ = Yes, ✗ = No

⁵⁾ The Battery-Box Premium HVL 12.0 is recommended only with the SBS3.8-US-10 or SBS5.0-US-10 due to limited charging and discharging power. When used with the SBS6.0-US-10, the inverter's nominal power of 6 kW is not reached.

⁶⁾ The use in battery-backup systems is only possible to a limited extent (see "Technical Statement - LG Energy Solution RESU10H when used in AC-Coupled Battery Backup Systems" at <http://www.SMA-Solar.com>).

2 Battery Communication Connection

2.1 Cable Requirements

2.1.1 SBS2.5-1VL-10

- Twisted pair conductors
- Cable category: minimum CAT5e
- Cable with shielding: Yes
- Conductor cross-section: 0.25 mm² to 0.34 mm² (24 AWG to 16 AWG)
- Recommended number of conductor pairs: 4
- Maximum cable length: 10 m (33 ft)
- The cable has to be insulated for 600 V.
- UV-resistant for outdoor use. SMA Solar Technology AG recommends the cable "UC900 SS23 Cat.7 PE"
- Comply with the requirements of the battery manufacturer.

2.1.2 SBS3.7-10 / SBS5.0-10 / SBS6.0-10

- Twisted pair conductors
- Cable category: minimum CAT5e
- Cable with shielding: Yes
- Conductor cross-section: 0.25 mm² to 0.34 mm² (24 AWG to 16 AWG)
- External diameter: 6 mm to 8.5 mm (0.24 in to 0.33 in)
- Recommended number of conductor pairs: 4
- Maximum cable length between battery and inverter and, in battery-backup systems, between automatic transfer switch and inverter: 10 m (33 ft)
- The cable has to be insulated for 600 V.
- UV-resistant for outdoor use.
- Comply with the requirements of the battery manufacturer.

2.1.3 SBS3.8-US-10 / SBS5.0-US-10 / SBS6.0-US-10

- Twisted pair conductors
- Cable category: minimum CAT5e
- Cable with shielding: Yes
- Conductor cross-section: 0.25 mm² to 0.34 mm² (24 AWG to 16 AWG)
- External diameter: 6 mm to 8.5 mm (0.24 in to 0.33 in)
- Recommended number of conductor pairs: 4
- Maximum cable length between battery and inverter and, in battery-backup systems, between automatic transfer switch and inverter: 10 m (33 ft)
- If the cables are routed together with the DC conductors in a conduit, each cable has to be insulated for 600 V.
- UV-resistant for outdoor use.
- Comply with the requirements of the battery manufacturer.

2.2 Cabling Plan

2.2.1 SBS2.5-1VL-10

Sunny Boy Storage with LG Energy Solution RESU 7H / RESU 10H

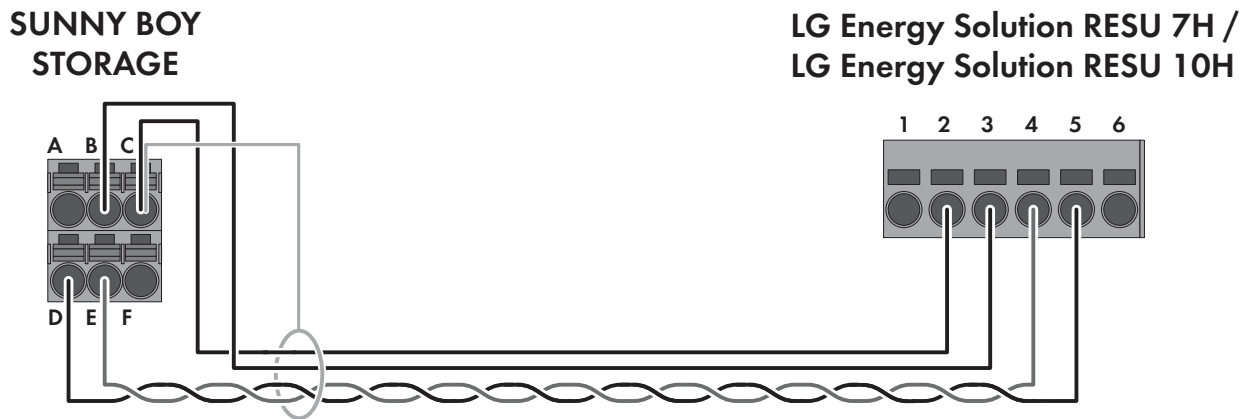

Figure 1: Cabling plan SBS2.5-1VL-10 with RESU 7H / RESU 10H

Clamping position	Assignment	Pin
A	Not used	-
B	Enable 11 V+	3
C	GND and shielding	2
D	CAN L (twisted pair conductors, at least CAT5e)	5
E	CAN H (twisted pair conductors, at least CAT5e)	4
F	Not used	-

Sunny Boy Storage with BYD Battery-Box H

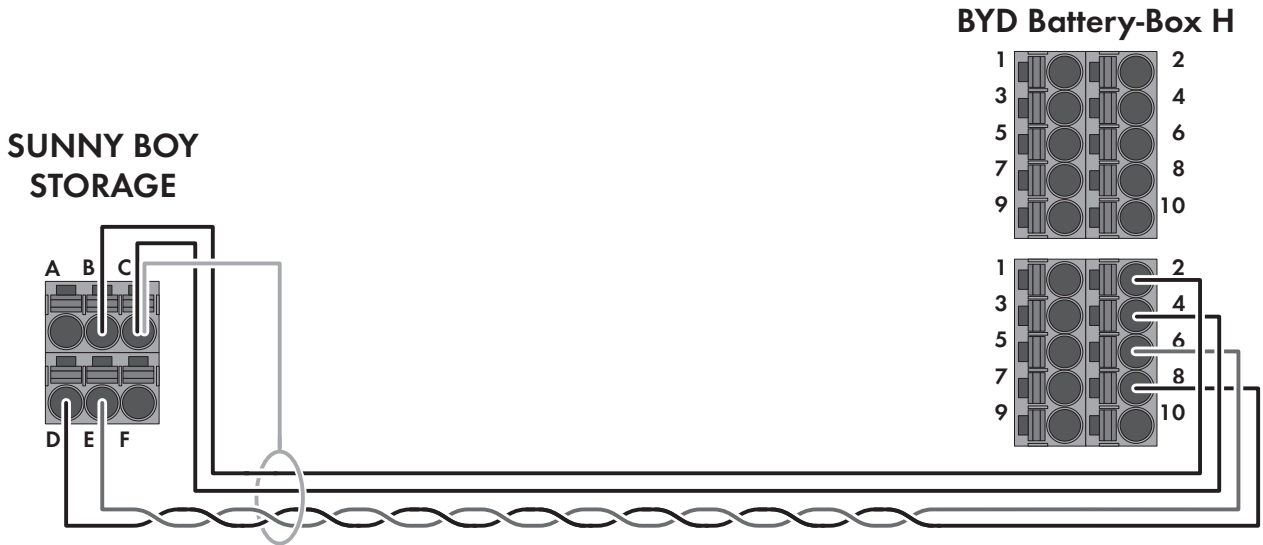

Figure 2: Cabling plan SBS2.5-1VL-10 with Battery-Box H

Clamping position	Assignment	Pin
A	Not used	-
B	Enable 11 V+	2
C	GND and shielding	4
D	CAN L (twisted pair conductors, at least CAT5e)	8
E	CAN H (twisted pair conductors, at least CAT5e)	6
F	Not used	-

Sunny Boy Storage with BYD Battery-Box Premium HVS

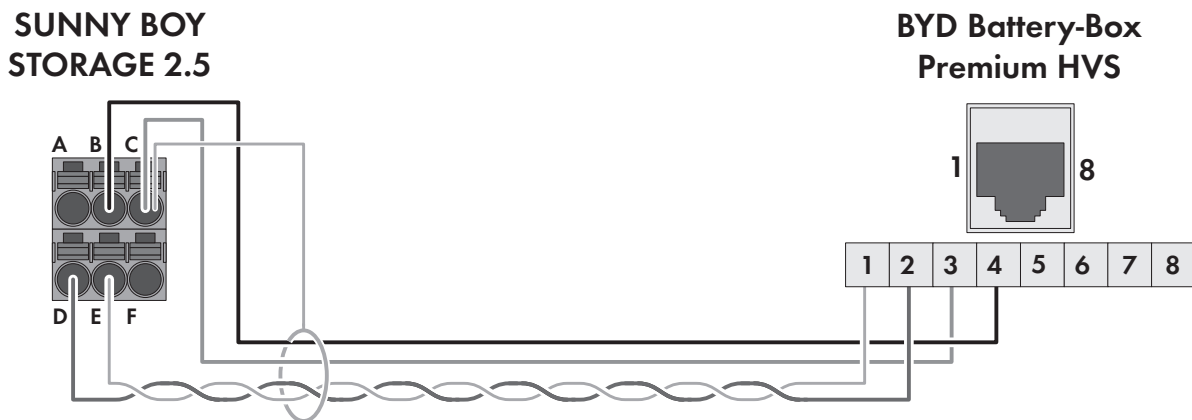

Figure 3: Cabling plan SBS2.5-1VL-10 with Battery-Box Premium HVS

Clamping position	Assignment	Pin
A	Not used	-
B	Enable 11 V+	4

Clamping position	Assignment	Pin
C	GND and shielding	3
D	CAN L (twisted pair conductors, at least CAT5e)	2
E	CAN H (twisted pair conductors, at least CAT5e)	1
F	Not used	-

2.2.2 SBS3.7-10 / SBS5.0-10 / SBS6.0-10

Sunny Boy Storage with LG Energy Solution RESU 7H / RESU 10H

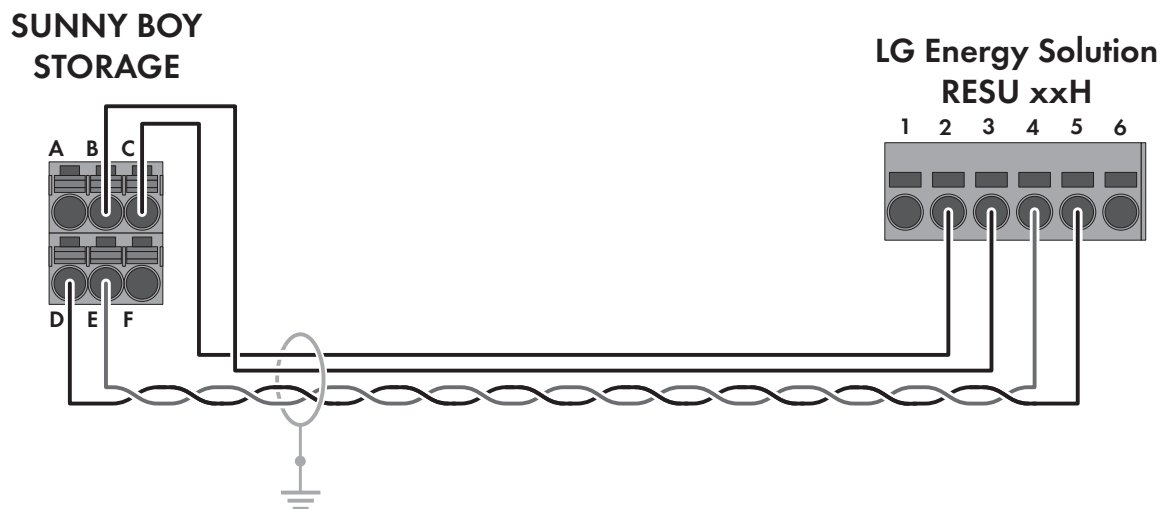

Figure 4: Cabling plan SBS3.7-10 / SBS5.0-10 / SBS6.0-10 with RESU 7H / RESU 10H

Clamping position	Assignment	Pin
A	Not used	-
B	Enable 11 V+	3
C	GND and shielding	2
D	CAN L (twisted pair conductors, at least CAT5e)	5
E	CAN H (twisted pair conductors, at least CAT5e)	4
F	+ 12 V supply for automatic transfer switching device	-

Sunny Boy Storage 3.7 with LG Energy Solution RESU 10M

SUNNY BOY STORAGE 3.7

LG Energy Solution RESU 10M

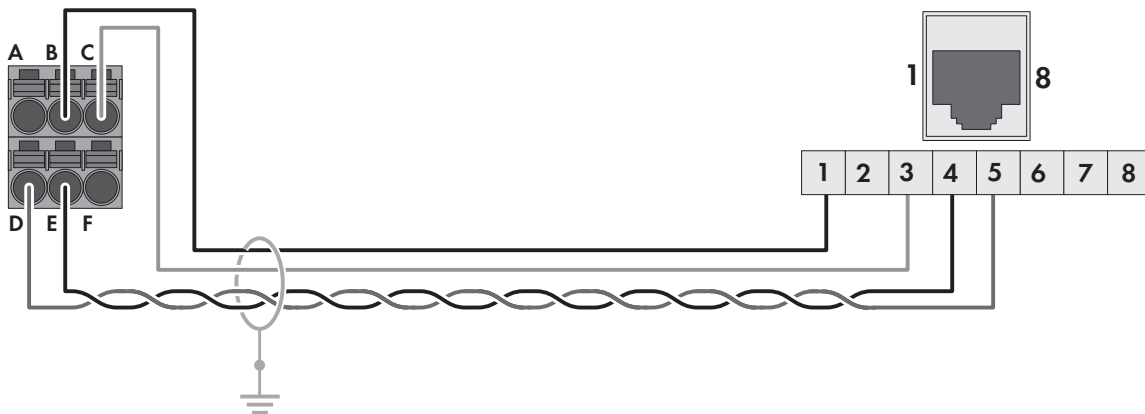

Figure 5: Cabling plan SBS3.7-10 with RESU 10M

Clamping position	Assignment	Pin
A	Not used	-
B	Enable 11 V+	1
C	GND and shielding	3
D	CAN L (twisted pair conductors, at least CAT5e)	5
E	CAN H (twisted pair conductors, at least CAT5e)	4
F	+12V supply for automatic transfer switching device	-

Sunny Boy Storage with LG Energy Solution RESU 10H Prime / RESU 16H Prime

SUNNY BOY STORAGE

LG Energy Solution RESU 10H Prime/16H Prime

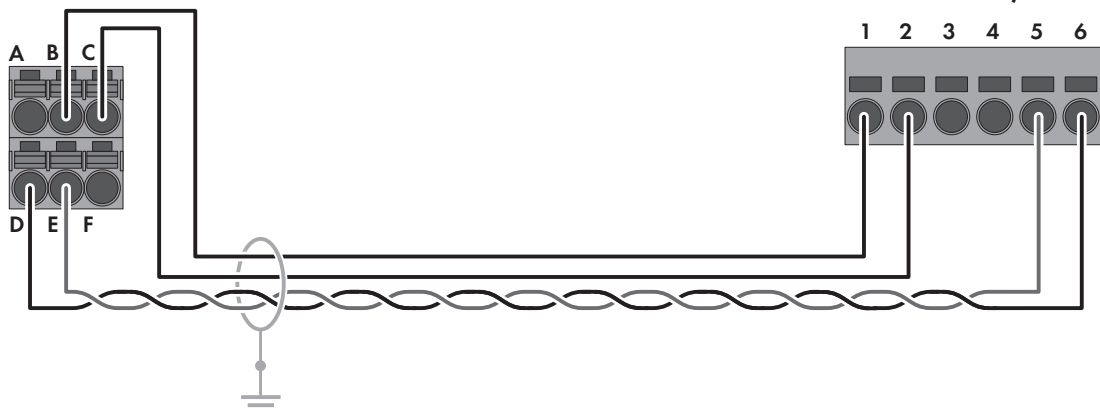

Figure 6: Cabling plan SBS3.7-10 / SBS5.0-10 / SBS6.0-10 with RESU 10H Prime / 16H Prime

Clamping position	Assignment	Pin
A	Not used	-
B	Enable 11 V+	1

Clamping position	Assignment	Pin
C	GND and shielding	2
D	CAN L (twisted pair conductors, at least CAT5e)	6
E	CAN H (twisted pair conductors, at least CAT5e)	5
F	+12V supply for automatic transfer switching device	-

Sunny Boy Storage with LG Energy Solution RESU Flex

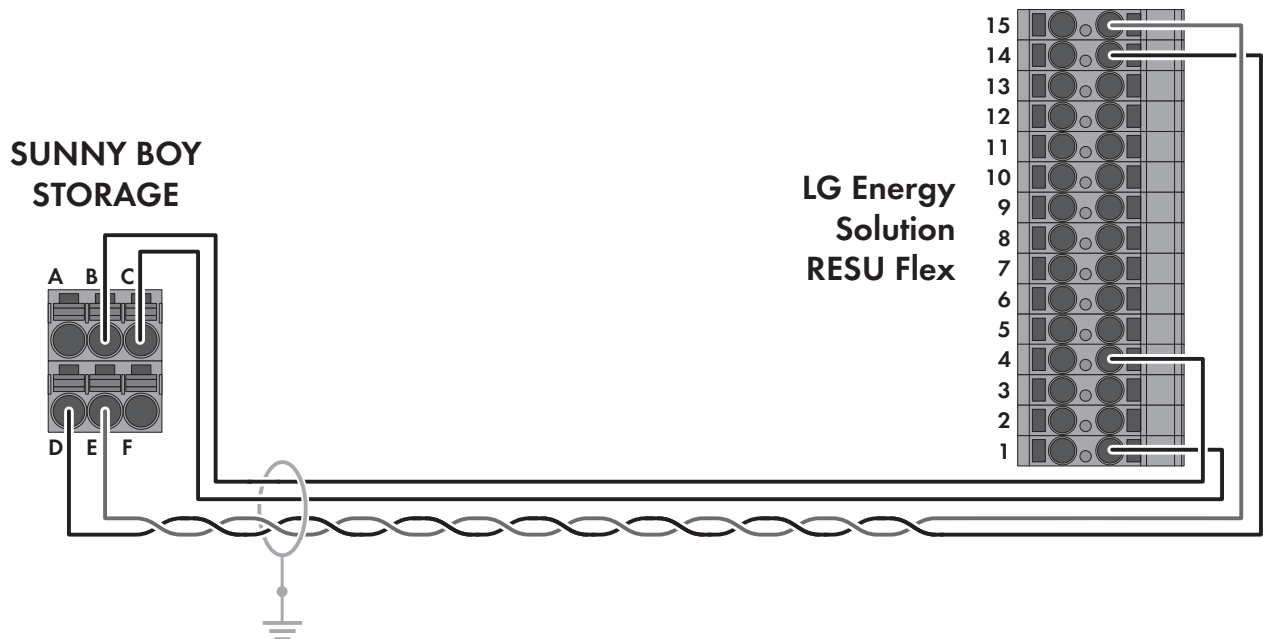

Figure 7: Cabling plan SBS3.7-10 / SBS5.0-10 / SBS6.0-10 with RESU Flex

Clamping position	Assignment	Pin
A	Not used	-
B	Enable 11 V+	4
C	GND and shielding	1
D	CAN L (twisted pair conductors, at least CAT5e)	14
E	CAN H (twisted pair conductors, at least CAT5e)	15
F	+12V supply for automatic transfer switching device	-

Sunny Boy Storage with BYD Battery-Box H

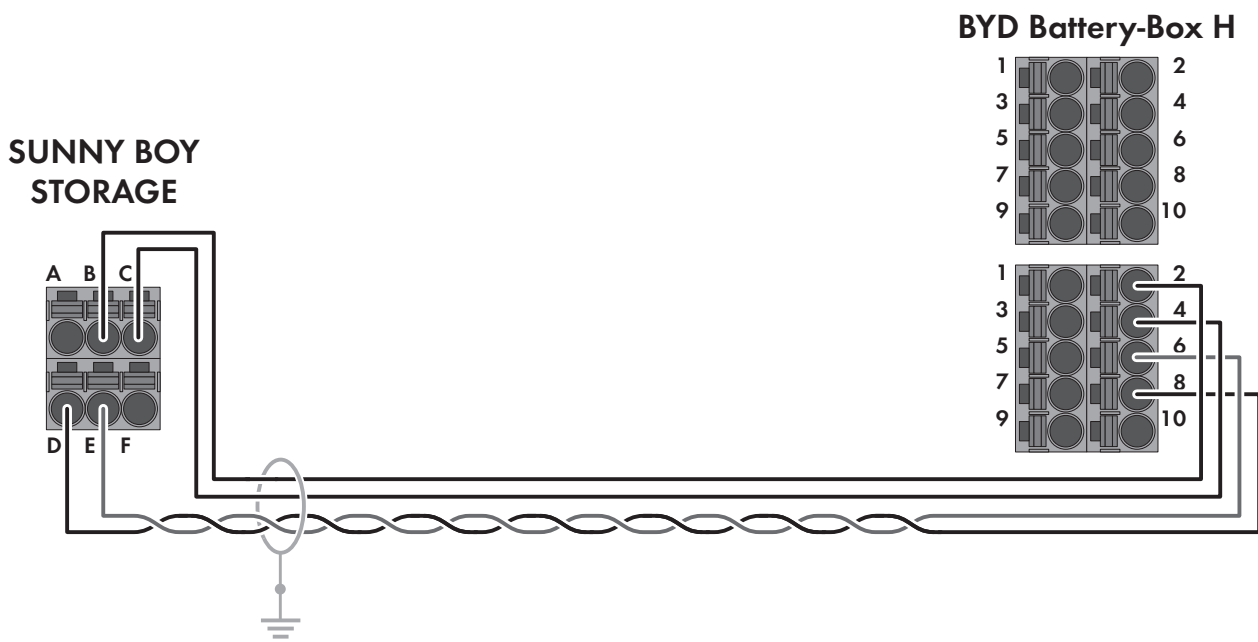

Figure 8: Cabling plan SBS3.7-10 / SBS5.0-10 / SBS6.0-10 with Battery-Box H

Clamping position	Assignment	Pin
A	Not used	-
B	Enable 11 V+	2
C	GND and shielding	4
D	CAN L (twisted pair conductors, at least CAT5e)	8
E	CAN H (twisted pair conductors, at least CAT5e)	6
F	+12V supply for automatic transfer switching device	-

Sunny Boy Storage with BYD Battery-Box Premium HVS and HVM

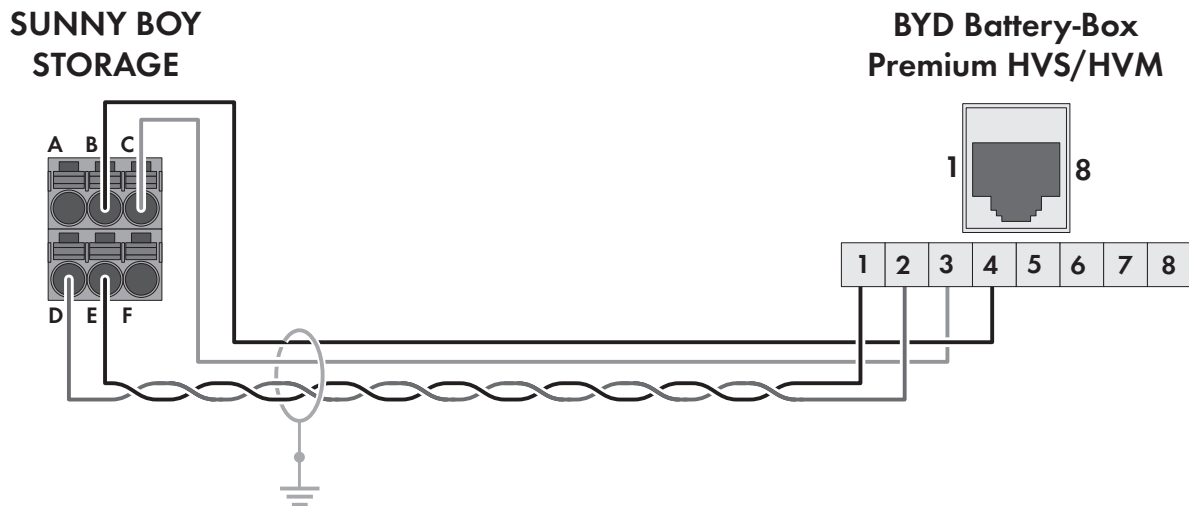

Figure 9: Cabling plan SBS3.7-10 / SBS5.0-10 / SBS6.0-10 with Battery-Box Premium HVS and HVM

Clamping position	Assignment	Pin
A	Not used	-
B	Enable 11 V+	4
C	GND and shielding	3
D	CAN L (twisted pair conductors, at least CAT5e)	2
E	CAN H (twisted pair conductors, at least CAT5e)	1
F	+12V supply for automatic transfer switching device	-

Sunny Boy Storage with BMZ Hyperion, IBC SOLAR era:powerbase and Axitec AXIstorage Li SH

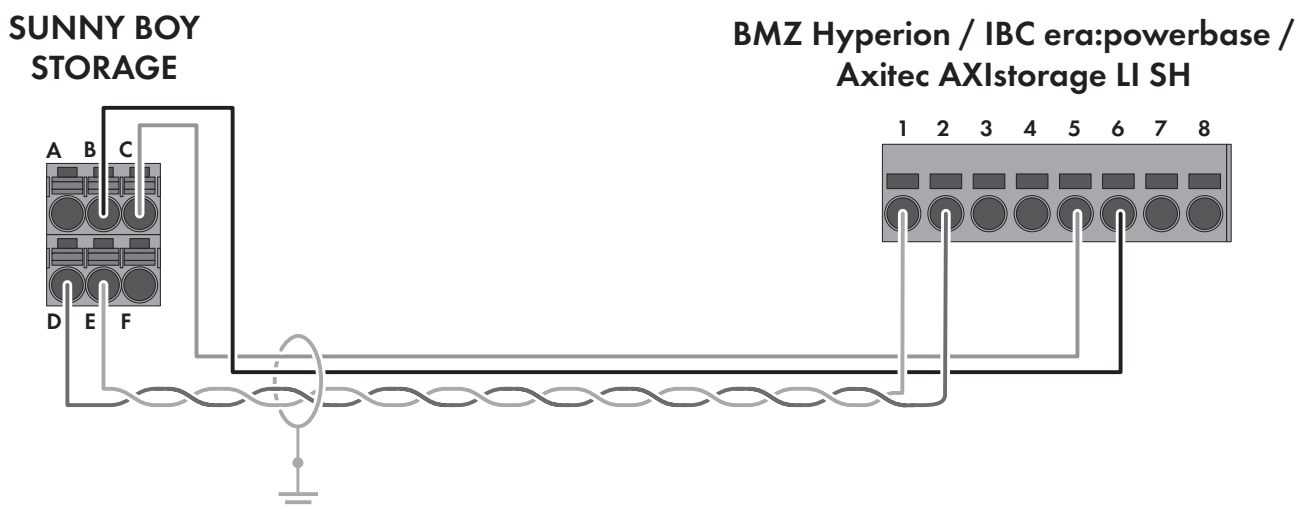

Figure 10: Cabling plan SBS3.7-10 / SBS5.0-10 / SBS6.0-10 with BMZ Hyperion, IBC era:powerbase and Axitec AXIstorage Li SH

Clamping position	Assignment	Clamping position
A	Not used	-
B	Enable 11 V+	6 (orange)

Clamping position	Assignment	Clamping position
C	GND and shielding	5 (blue)
D	CAN L (twisted pair conductors, at least CAT5e)	2 (white)
E	CAN H (twisted pair conductors, at least CAT5e)	1 (yellow)
F	+12V supply for automatic transfer switching device	-

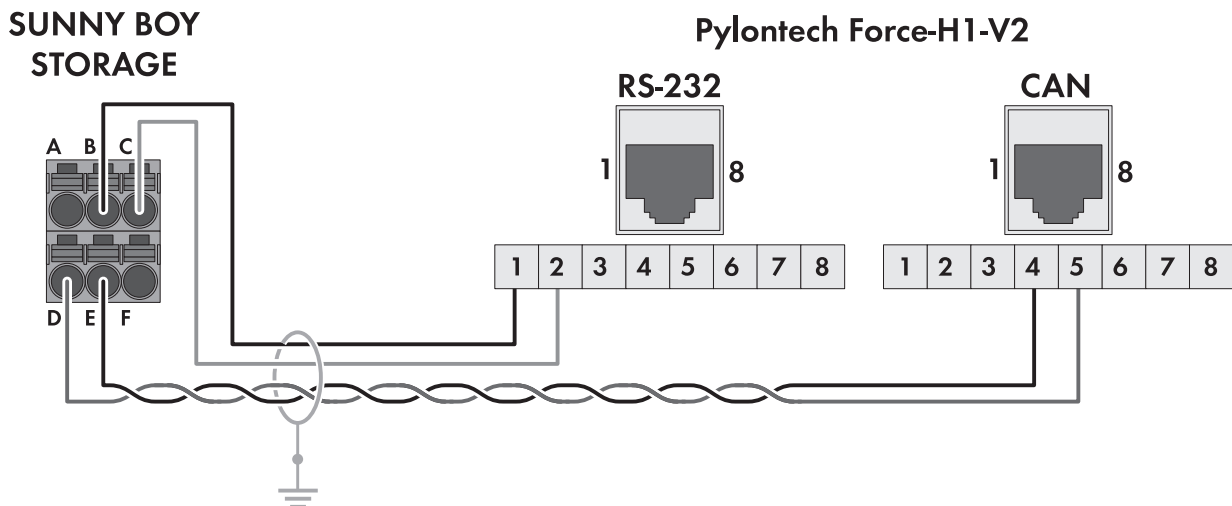

Figure 11: Cabling plan SBS3.7-10 / SBS5.0-10 / SBS6.0-10 with Pylontech Force-H1-V2

Clamping position	Assignment	Clamping position
A	Not used	-
B	Enable 11 V+	1 (RS-232)
C	GND and shielding	2 (RS-232)
D	CAN L (twisted pair conductors, at least CAT5e)	5 (CAN)
E	CAN H (twisted pair conductors, at least CAT5e)	4 (CAN)
F	+12V supply for automatic transfer switching device	-

SUNNY BOY STORAGE

Pylontech Force-H2-V2

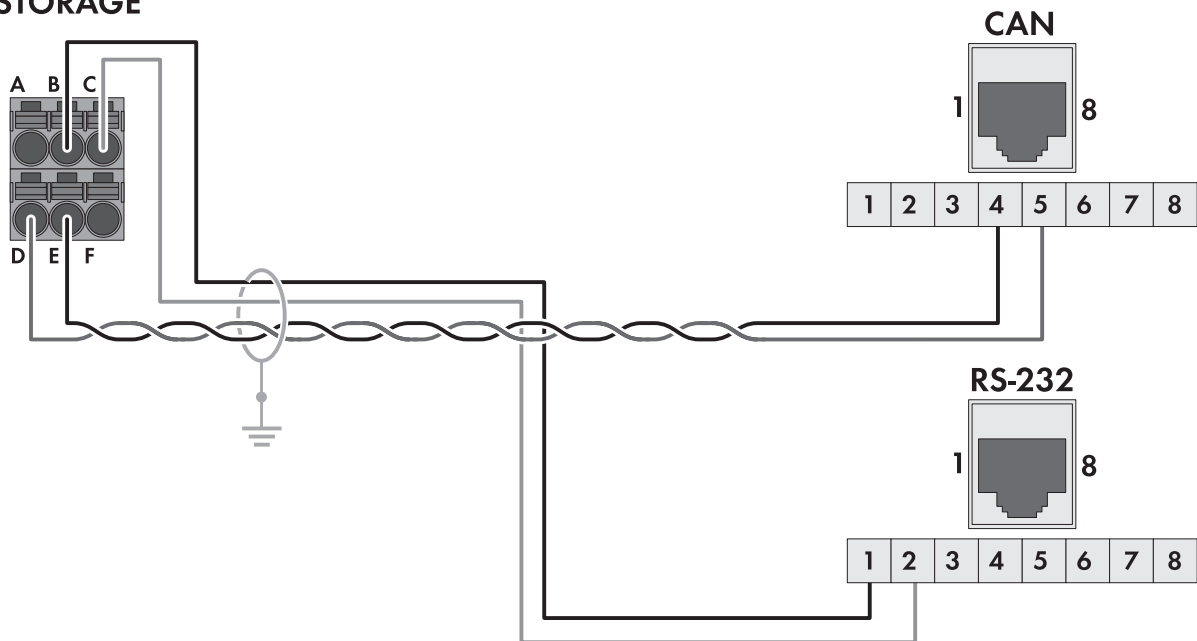

Figure 12: Cabling plan SBS3.7-10 / SBS5.0-10 / SBS6.0-10 with Pylontech Force-H2-V2

Clamping position	Assignment	Clamping position
A	Not used	-
B	Enable 11 V+	1 (RS-232)
C	GND and shielding	2 (RS-232)
D	CAN L (twisted pair conductors, at least CAT5e)	5 (CAN)
E	CAN H (twisted pair conductors, at least CAT5e)	4 (CAN)
F	+12V supply for automatic transfer switching device	-

2.2.3 SBS3.8-US-10 / SBS5.0-US-10 / SBS6.0-US-10

Sunny Boy Storage with LG Energy Solution RESU 7H / RESU 10H

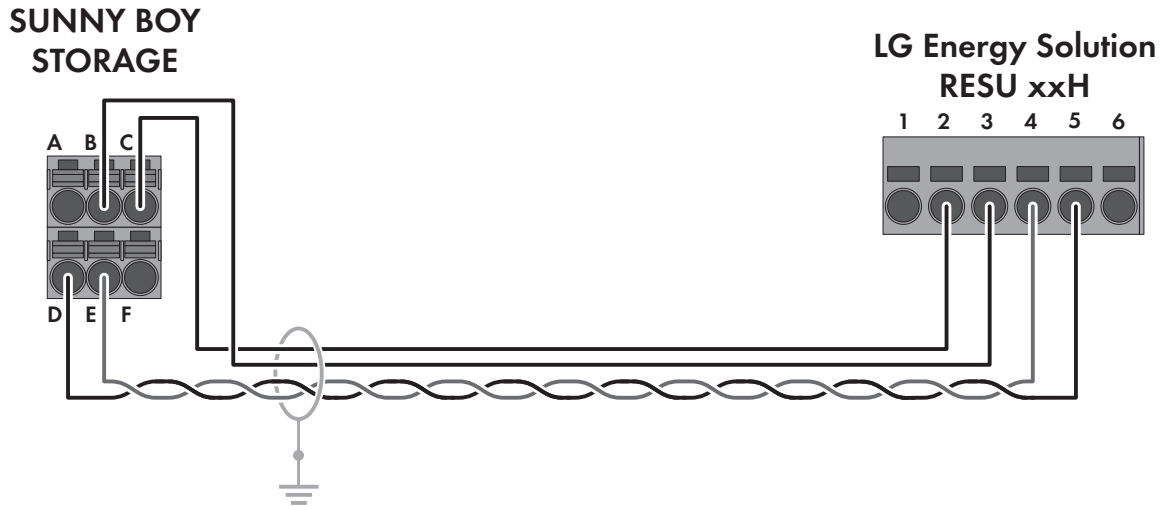

Figure 13: Cabling plan SBS3.8-US-10 / SBS5.0-US-10 / SBS6.0-US-10 with RESU 7H / RESU 10H

Clamping position	Assignment	Pin
A	Not used	-
B	Enable 11 V+	3
C	GND and shielding	2
D	CAN L (twisted pair conductors, at least CAT5e)	5
E	CAN H (twisted pair conductors, at least CAT5e)	4
F	+12V supply for automatic transfer switching device	-

Sunny Boy Storage with BYD Battery-Box H

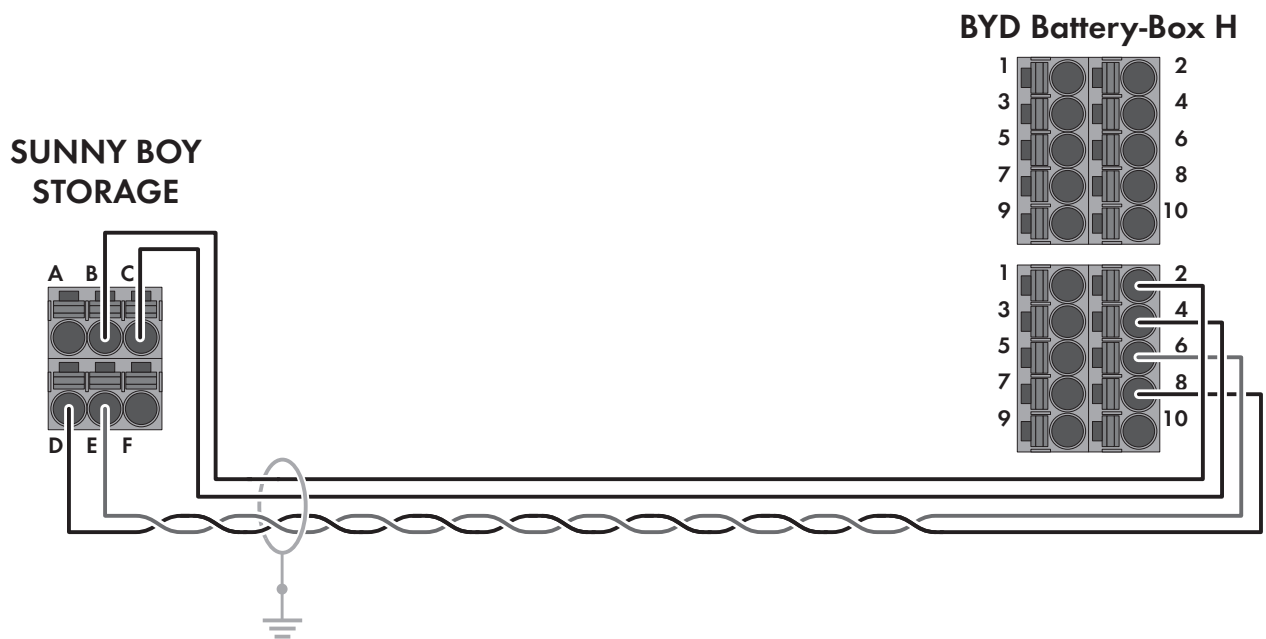

Figure 14: Cabling plan SBS3.8-US-10 / SBS5.0-US-10 / SBS6.0-US-10 with BYD Battery-Box H

Clamping position	Assignment	Pin
A	Not used	-
B	Enable 11 V+	2
C	GND and shielding	4
D	CAN L (twisted pair conductors, at least CAT5e)	8
E	CAN H (twisted pair conductors, at least CAT5e)	6
F	+12V supply for automatic transfer switching device	-

Sunny Boy Storage with BYD Battery-Box Premium HVL

SUNNY BOY STORAGE

BYD Battery-Box Premium HVL

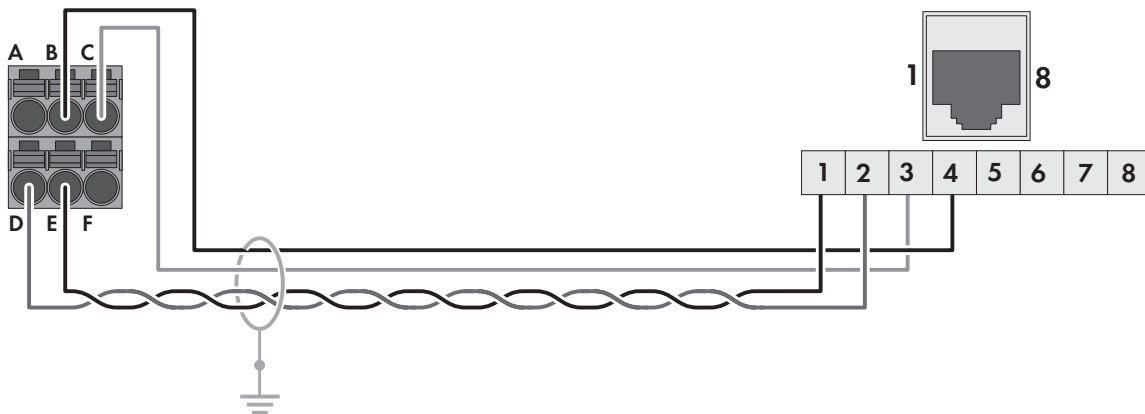

Clamping position	Assignment	Pin
A	Not used	-
B	Enable 11 V+	4
C	GND and shielding	3
D	CAN L (twisted pair conductors, at least CAT5e)	2
E	CAN H (twisted pair conductors, at least CAT5e)	1
F	+12V supply for automatic transfer switching device	-

Sunny Boy Storage with LG Energy Solutions RESU 16H Prime

SUNNY BOY STORAGE

LG Energy Solution RESU 16H Prime

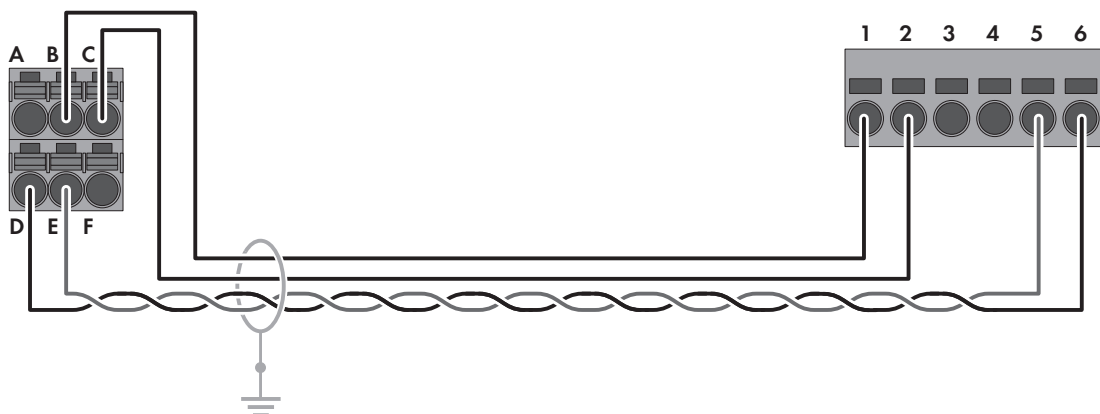

Figure 15: Cabling plan SBS3.8-US-10 / SBS5.0-US-10 / SBS6.0-US-10 with RESU 16H Prime

Clamping position	Assignment	Pin
A	Not used	-
B	Enable 11 V+	1

Clamping position	Assignment	Pin
C	GND and shielding	2
D	CAN L (twisted pair conductors, at least CAT5e)	6
E	CAN H (twisted pair conductors, at least CAT5e)	5
F	+12V supply for automatic transfer switching device	-

3 Information about the electrical connection

Connection of batteries with a charging/discharging current limit of 20 A

This terminal must be selected for the following batteries:

- LG RESU 7H
- LG RESU 10H

When using an RESU 7H or RESU 10H, not all bridges must be plugged in.

Procedure:

The DC terminals A and B must be switched parallelly using the jumpers provided.

The battery must be connected to the terminal blocks **A+** and **A-**.

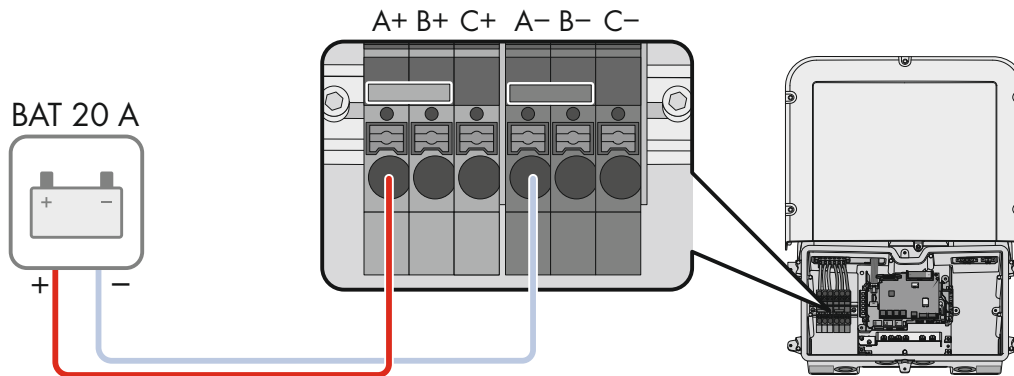

Figure 16: Overview for connection of a battery with a charging/discharging current limit of 20 A

Connection of a battery with a charging/discharging current higher than 20 A

This connection is recommended for the following batteries:

- LG RESU 10M
- LG RESU 10H Prime
- LG RESU 16H Prime
- LG RESU Flex 8.6-17.2
- BYD Battery-Box H 5.1-10.2
- BYD Battery-Box Premium HVS 5.1-10.2
- BYD Battery-Box Premium HVM 8.3-22.1
- BYD Battery-Box Premium HVL 12.0-32.0
- BMZ Hyperion 7.5-15
- IBC SOLAR era:powerbase 7.5-15
- Axitec AXIstorage Li SH 7.5-15
- Pylontech Force-H1-V2 (10.65-24.86)
- Pylontech Force-H2-V2 (7.10-14.20)

Procedure:

All DC terminals must be switched parallelly with the jumpers provided.

The battery must be connected to the terminal blocks **A+** and **A-**.

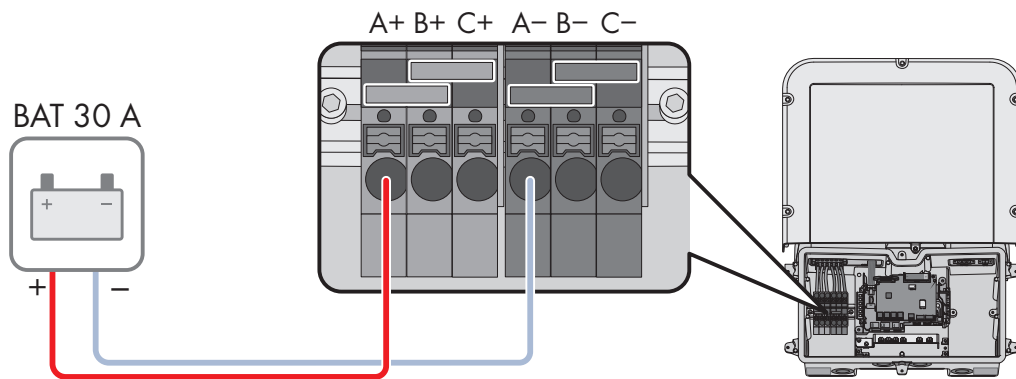

Figure 17: Overview for connection of one battery with a charging/discharging current higher than 20 A.

General Information

i From Sunny Boy Storage FW 3.11.03.R

The DC input current of the inverter is additionally monitored. If the limit of 40 A is exceeded, the battery is automatically switched off for protection. This results in a permanent operation inhibition. It is therefore not necessary to install an external fuse between battery and Sunny Boy Storage for all listed batteries, even those with output currents greater than 40 A.

i Parameterization of the upper battery charging limit

Unlike with lead-acid batteries, a parameterization of the upper battery charging limit does not make sense when using lithium-ion batteries.

In each lithium-ion battery there is a battery management system (BMS), which dynamically adapts the limiting values depending on the module temperature, the state of charge of the battery (SOC) and also individual cells, thus optimizing the service life of the battery. Thus, the upper battery charging limit is adapted on its own through the BMS. In addition, it is important to approach the upper battery charging limit at longer intervals in order to prevent the cells connected in series from drifting apart. With this type of calibration, the 100% SOC value of the battery is re-learned and the displayed value is thus synchronized with the actual state of charge of the battery. For the reasons mentioned, the parameter for the upper battery charging limit is still partly visible in the Sunny Boy Storage and Sunny Tripower Smart Energy does not have any function when using lithium-ion batteries.

i This document does not replace any regional, state, provincial, federal or national laws, regulations or standards that apply to the installation, electrical safety and use of the product. Always observe the local regulations as well.

ENERGY
THAT
CHANGES



www.SMA-Solar.com

